

LEFT SIDE

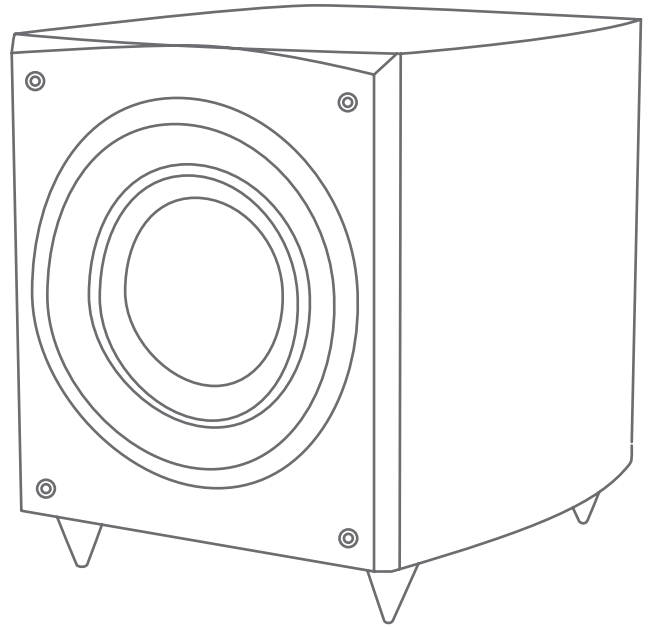

FRONT

RIGHT SIDE

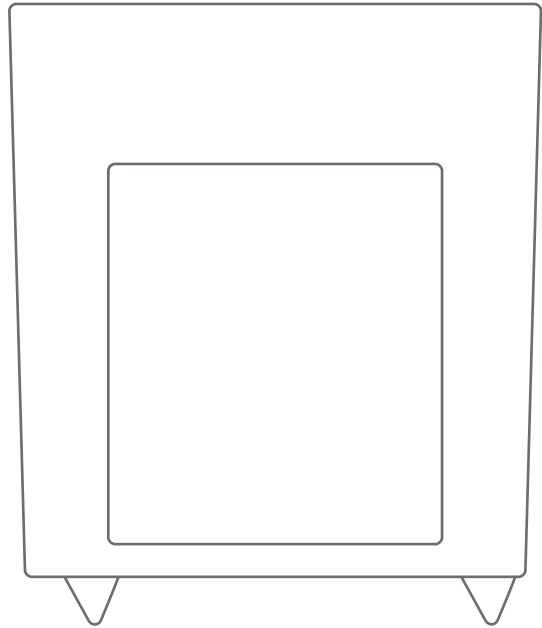

BACK

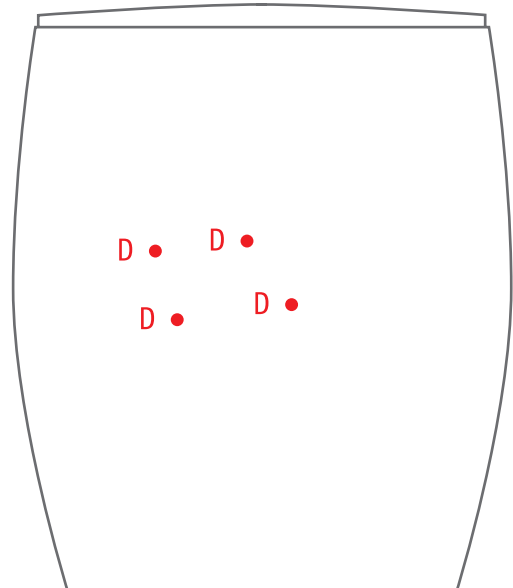

TOP

SUBWOOFER "B STOCK" DAMAGE REPORT

MODEL: **ES10i** Color: Red Burl Black

S/N: **IS-042909-00222**

ADDITIONAL NOTES:

INSPECTED BY: **RH**

CODES	S = Scratches or surface flaws/hazy finish.
	F = Finger prints or flaws under clear coat.
	D = Dents or impressions in cabinet.
	G = Gaps or fit/alignment issues.
	C = Cosmetic driver issues